

788157-2 ✓ ACTIVE

AMP | AMP CPC

TE Internal #: 788157-2

Circular Power Connectors, Housing, 600 VDC, Wire-to-Wire, 9 Position, Sealable, Wire & Cable, Plug, Socket, Signal, Black, All Plastic, AMP CPC

[View on TE.com >](#)



Connectors > Power Connectors > Circular Power > Circular Power Connectors > One-Piece Connector, Sealed, CPC Series 1



Connector Product Type: **Housing**

Operating Voltage: **600 VDC**

Connector System: **Wire-to-Wire**

Number of Positions: **9**

Sealable: **Yes**

[All One-Piece Connector, Sealed, CPC Series 1 \(33\)](#)

Features

Product Type Features

Connector Seal & Plug Type	Wire Entry Seal
Connector Product Type	Housing
Connector System	Wire-to-Wire
Sealable	Yes
Connector & Contact Terminates To	Wire & Cable
Connector & Housing Type	Plug
Circular Connector Shell Type	All Plastic

Configuration Features

Reverse Numbering	With
Number of Positions	9
Number of Power Positions	0
Number of Signal Positions	9



Electrical Characteristics

Operating Voltage	600 VAC
-------------------	---------

Contact Features

Reverse Gender	No
Contact Type	Socket
Contact Protection	With

Mechanical Attachment

Mating Alignment Type	Keyed
Mating Alignment	With
Mating Retention Type	Threaded Coupling
Thread Size	3/4 - 20 UNEF-2A
Polarization Code	A
Connector Mounting Type	Cable Mount (Free-Hanging)
Mating Retention	With
Panel Mount Feature	Without

Housing Features

Body Orientation	Straight
Housing Color	Black
Housing Material	Nylon
Circular Connector Shell Size	13

Dimensions

Compatible Insulation Diameter Range	1.65 – 3.05 mm [.065 – .12 in]
--------------------------------------	--------------------------------

Usage Conditions

Operating Temperature Range	-55 – 105 °C [-67 – 221 °F]
Fluid Resistance	Immersion

Operation/Application

Circuit Application	Signal
Shielded	No

Industry Standards

UL Flammability Rating	UL 94V-0
------------------------	----------

Packaging Features

Packaging Quantity	100
--------------------	-----

Packaging Method

Bag

Product Compliance

For compliance documentation, visit the product page on [TE.com](#)>

EU RoHS Directive 2011/65/EU

Compliant

EU ELV Directive 2000/53/EC

Compliant

China RoHS 2 Directive MIIT Order No 32, 2016

No Restricted Materials Above Threshold

EU REACH Regulation (EC) No. 1907/2006

Current ECHA Candidate List: JUNE 2024 (241)
Candidate List Declared Against: JUNE 2024 (241)
Does not contain REACH SVHC

Halogen Content

BFR/CFR/PVC Free, but Br/Cl >900 ppm in other sources.

Solder Process Capability

Not applicable for solder process capability

Product Compliance Disclaimer

This information is provided based on reasonable inquiry of our suppliers and represents our current actual knowledge based on the information they provided. This information is subject to change. The part numbers that TE has identified as EU RoHS compliant have a maximum concentration of 0.1% by weight in homogenous materials for lead, hexavalent chromium, mercury, PBB, PBDE, DBP, BBP, DEHP, DIBP, and 0.01% for cadmium, or qualify for an exemption to these limits as defined in the Annexes of Directive 2011/65/EU (RoHS2). Finished electrical and electronic equipment products will be CE marked as required by Directive 2011/65/EU. Components may not be CE marked. Additionally, the part numbers that TE has identified as EU ELV compliant have a maximum concentration of 0.1% by weight in homogenous materials for lead, hexavalent chromium, and mercury, and 0.01% for cadmium, or qualify for an exemption to these limits as defined in the Annexes of Directive 2000/53/EC (ELV). Regarding the REACH Regulation, the information TE provides on SVHC in articles for this part number is based on the latest European Chemicals Agency (ECHA) 'Guidance on requirements for substances in articles' posted at this URL: <https://echa.europa.eu/guidance-documents/guidance-on-reach>

Compatible Parts



TE Part # CAT-AM71-C83998B
CPC Cable Clamps



TE Part # CAT-AM71-C83998HH
CPC SEALED ACCESSORIES



TE Part # 54123-1
CPC,13 LONG TUBE



TE Part # 81665-4
ECONOSEAL, FLANGE GASKET





TE Part # CAT-AM71-C83998Y
One-Piece Connector, Sealed, CPC Series 1



TE Part # CAT-AM71-T98
Pin and Socket Contacts, Type II



TE Part # CAT-AM71-T98E
Pin and Socket Contacts, Type III, LP



TE Part # CAT-AM71-T98D
Pin and Socket Contacts, Type III, LP EMEA



TE Part # CAT-AM71-T98A
Strip Pin and Socket Contacts, Type III, LP



TE Part # CAT-AM71-T98G
Pin and Socket Contacts, Type III, LP, High Current



TE Part # CAT-AM71-T98B
Strip Pin and Socket Contacts, Type III



TE Part # CAT-AM71-T98F
Strip Pin and Socket Contacts, Type III, High Current



TE Part # 91542-1
CCII TYPE III+ PIN SKT 24-22 ASSY



TE Part # 91515-1
CCII TYPE III+ MNL PIN SKT 30-20 ASSY



TE Part # 91519-1
CCII TYPE III+ PIN SKT 18-14 ASSY



TE Part # 58495-1
PRO CRIMPER ASSY MULTIMATE



TE Part # 208338-1
SEAL PROTECTOR SOCKET



TE Part # 193846-1
SKT ASSY.



TE Part # 201613-1
CONTACT SOCKET ASSY.



TE Part # 1-66359-9
III+PIN,18-14,TIN,STRIP

Also in the Series | AMP CPC



Circular Power Connectors(458)



Connector Backshells(1)



Connector Caps & Covers(19)

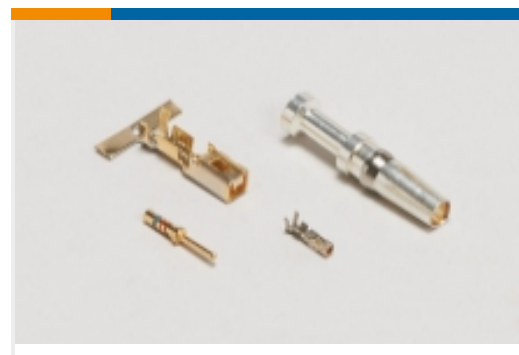

Connector Contacts(6)



Connector Hardware(12)



Connector Seals & Cavity Plugs(36)



Connector Strain Relief(60)



Insertion & Extraction Tools(1)

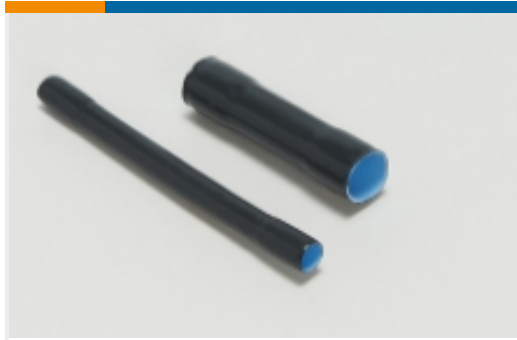

Sealing Sleeves(2)

Customers Also Bought



TE Part #796095-2
One-Piece Connector, Sealed, CPC
Series 1



TE Part #62276-1
250 FASTON REC 18-14 AWG TPBR



TE Part #1-2112780-5
18POS, MIXED, REC HSG, ASSY,
SEALED



TE Part #1897711-2
MQS, CONNECTOR HOUSING
SEALED

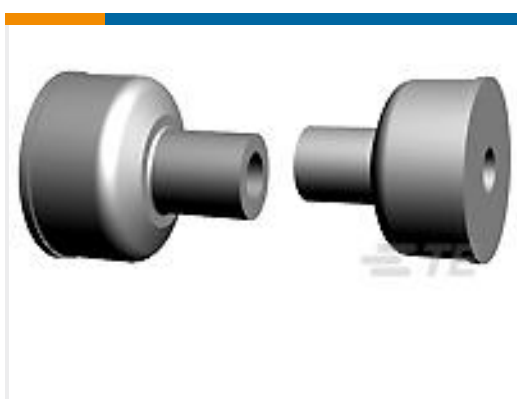

TE Part #347713-1
2.0MM CABLE SEAL HC SILIC



TE Part #EL6483-000
RBK-85-KIT-0107-A0

Documents

Product Drawings

[SLD CPC PLUG ASSY,13-9,STD SEX](#)

English

CAD Files

[Customer View Model](#)

[ENG_CVM_788157-2_B.3d_stp.zip](#)

English

[Customer View Model](#)



[ENG_CVM_788157-2_B.2d_dxf.zip](#)

English

Customer View Model

[ENG_CVM_788157-2_B.3d_igs.zip](#)

English

3D PDF

English

3D PDF

3D

Customer View Model

[ENG_CVM_CVM_788157-2_D.2d_dxf.zip](#)

English

Customer View Model

[ENG_CVM_CVM_788157-2_D.3d_igs.zip](#)

English

Customer View Model

[ENG_CVM_CVM_788157-2_D.3d_stp.zip](#)

English

By downloading the CAD file I accept and agree to the [Terms and Conditions](#) of use.

Datasheets & Catalog Pages

[AMP Circular Connectors for Commercial Signal & Power Applications](#)

English

Product Specifications

[Application Specification](#)

English